

Sizes in millimeters
Dimensions en millimètres

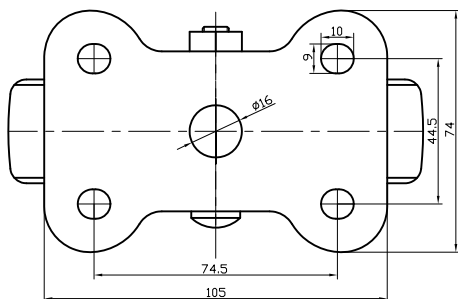

REFERENCE: F27276

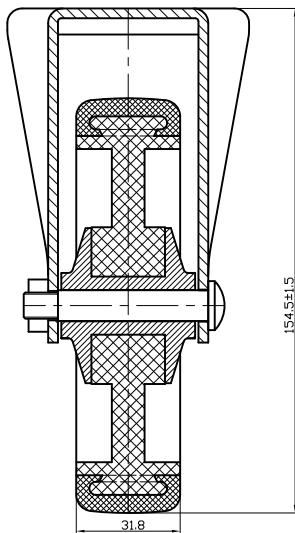
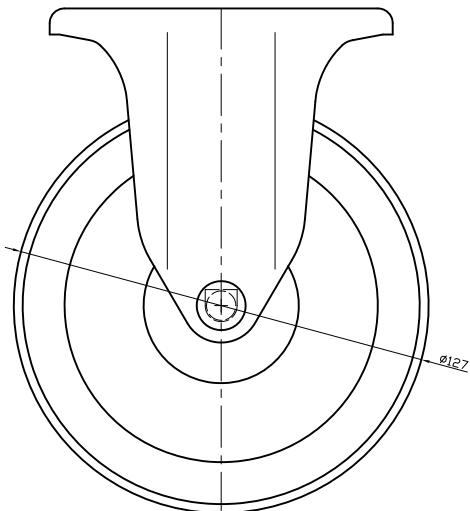